



RT 1080 L

80t capacity class
Rough terrain crane
Datasheet
metric

RT 1080 L



WORKS FOR YOU.™

	Page · Page · Seite · Pagina · Página · Página · Страница:
Key · Légende · Legende · Legenda · Lejenda · Legenda · Условные Обозначения	3
Highlights · Atouts majeurs · Produktmerkmale · Caratteristiche principali · Características destacadas · Destaques · Основные функции	4
Dimensions · Dimensions · Abmessungen · Dimensioni · Dimensiones · Dimensões · Размеры	5
Weights · Poids · Gewichte · Pesi · Pesos · Pesos · Вес	6
Steering Radii · Rayon de braquage · Lenkradien · Raggi di sterzata · Radios de dirección · Raios de giro · Радиусы поворотов	7
Range Graph · Diagramme de charge · Arbeitsbereich · Campo di portata · Diagrama de carga · Gráfico de alcance · Диаграмма рабочей зоны	8, 12
Load Chart · Graphique de charge · Traglasttabelle · Diagramma di carico · Tabla de carga · Tabela de carga · Таблица нагрузок	9- 11 13-14
Technical Specifications · Spécifications techniques · Technische Daten · Specifica tecnica · Especificacion tecnica · Especificações técnicas · Технические характеристики	
Boom · Flèche · Ausleger · Braccio · Pluma · Lança · Стрела	15
Hoist · Treuil · Hubwerk · Argano · Cabrestante · Guincho · Подъем	15
Upper Structure · Tourelle · Oberwagen · Superestructura · Sovrastruttura · Estrutura superior · Верхняя надстройка	16
Cab and Controls · Cabine et commandes · Kabine und Steuerung · Cabina e comandi · Cabina y controles · Cabine e controles · Кабина и органы управления	16
Carrier · Châssis · Unterwagen · Carro · Chasis · Chassi · Шасси	17
Vehicle Performance · Performances du véhicule · Fahrleistungen · Prestazioni veicolo · Prestaciones del vehículo · Desempenho do veículo · Характеристики автомобиля	18
Tires · Pneumatiques · Bereifung · Pneumatici · Neumáticos · Pneus · Шины	18
Options · Options · Optionen · Opzioni · Opciones · Opcionais · Дополнительные опции	18-20
Notes to lifting capacity · Notes relatives à la capacité de levage · Hinweis zu Tragfähigkeiten · Annotazioni sulle portate · Notas sobre la capacidad de elevación · Notas sobre a capacidade de içamento · Примечания по грузоподъемности	22

LÉGENDE · LEGENDE · LEGENDA · LEJENDA · LEGENDA · УСЛОВНЫЕ ОБОЗНАЧЕНИЯ

	Counterweight · Contrepoids · Gegengewicht · Contrappeso · Contrapeso · Contrapeso · Противовес		Boom extension · Extension de flèche · Ausleger-Verlängerung · Prolunga · Extensión · Extensão da lança · Удлинитель стрелы
	Main boom · Flèche principale · Hauptausleger · Braccio principale · Pluma principal · Lança principal · Главная стрела		Performance · Performance · Leistungswerte · Prestazioni · Prestaciones · Desempenho · Характеристики
	Boom length · Longueur de flèche · Auslegerlänge · Lunghezza del braccio · Longitud pluma · Comprimento da lança · Длина стрелы		Boom elevation angle · Angle de relevage de la flèche · Auslegerwinkel · Angolo di brandeggio · Ángulo elevación pluma · Ángulo elevação lança · Угол стрелы
	Tip height · Hauteur de déversement · Rollenhöhe · Altezza di testa · Altura de la punta · Altura da ponta · Высота вершины		Working radius · Portée · Ausladung · Raggio di lavoro · Radio de trabajo · Raio de operação · Рабочий радиус
	Angular offsets · Déports angulaires · Abwinkelbar · Inclinazioni · Inclinación · Desvío angular · Угловое смещение		Minimum distance between hook block and boom head · Distance entre crochet et tête de flèche · Haken bis Rollenachse · Distancia mínima tra bozzello e testa braccio · Distancia mínima gancho a cabeça pluma · Distância mínima entre moitão e cabeça da lança · Минимальное расстояние от крюка до оси шкива вершины
	Aux head · Tête auxiliaire · Zusatzkopf · Testa ausiliaria · Cabeza auxiliar · Cabeça auxiliar · Дополнительная головка		Slewing locked · Orientation bloquée · Schwenksperre · Rotazione bloccata · Giro bloqueado · Giro bloqueado · Поворот блокирован
	Slewing / Allowable range · Orientation / Rayon admissible · Schwenken / zulässiger Bereich · Rotazione / Angolo di rotazione permesso · Giro / Rango admisible · Giro / Amplitude admitida · Поворот/допуст. диапазон		Slewing gears · Réducteurs d'orientation · Schwenkwerk · Sistema di rotazione · Sistema de giro · Engrenagens do giro · Редукторы поворота
	Outriggers / Lifting on outriggers · Stabilisateurs / Levage sur stabilisateurs · Abstützungen / Hub mit Abstützung · Stabilizzatori / Sollevamento su stabilizzatori · Estabilizadores / Elevación sobre estabilizadores · Patolas / Elevação sobre patolas · Опоры/подъем на опорах		Lifting on wheels / Pick & Carry · Levage sur roues / Pick & Carry · Nicht abgestützter Hub / Pick & Carry · Sollevamento su ruote / Pick & Carry · Elevación sobre ruedas / pick & carry · Elevação sobre rodas / Guindaste industrial · Подъем на колесах/Подъем и перенос
	Main hoist · Treuil principal · Haupthubwerk · Argano principale · Cabrestante principal · Guincho principal · Главный подъем		Auxiliary hoist · Treuil auxiliaire · Zusatzhubwerk · Argano ausiliario · Cabrestante auxiliar · Guincho auxiliar · Вспомогательный подъем
	Hoist speed · Vitesse du treuil · Geschwindigkeit des Hubwerks · Velocità argano · Velocidad cabrestante · Velocidade guincho · Скорость подъема		Rope length · Longueur de câble · Seillänge · Lunghezza fune · Longitud cable · Compr. cabo · Длина троса
	Rope · Câble · Seil · Fune · Cable · Cabo · Трос		Line pull · Traction du câble · Seilzug · Tiro sulla fune · Tracción cable · Tração linha · Нагрузка на трос
	Rope diameter · Diamètre du câble · Seildurchmesser · Diametro della fune · Diámetro cable · Diámetro do cabo · Диаметр троса		Tires · Pneumatiques · Bereifung · Pneumatici · Neumáticos · Pneus · Шины
	Hook block · Crochet-moufle · Unterflasche · Bozzello · Gancho · Moitão · Крюкоблок		Engine · Moteur · Motor · Motore · Motor · Motor · Двигатель
	Cab · Cabine · Kabine · Cabina · Cabina · Cabine · Кабина		Steering · Direction · Lenkung · Sterzata · Dirección · Direção · Рулевое управление
	Controls · Commande · Bedienelemente · Comandi · Controles · Controles · Орг. управления		Speed · Vitesse · Fahrgeschwindigkeit · Velocità di traslazione · Velocidad · Velocidade · Скорость
	Mechanical transmission · Méc. transmission · Schaltgetriebe · Trasmisioe meccanica · Trasmisión mecánica · Transmissão mecânica · Механическая трансмиссия		Heating / Air conditioning · Chauffage / Climatisation · Heizung / Klimaanlage · Riscaldamento / Aria condizionata · Calefacción / Climatización · Calefação / Ar condicionado · Обогрев/кондиционер
	HYDR · Hydraulics · Hydraulique · Hydraulik · Sistema idraulico · Sistema hidráulico · Sistema hidráulico · Гидравлическая система		Gradeability · Tenue de route en côte · Steigfähigkeit · Inclinazione massima superabile · Pendiente máx. · Capacidade de rampa · Способность преодолевать подъем
	Operation temperature · Température de service · Betriebstemperatur · Temperatura di lavoro · Temperatura de servicio · Temperatura operação · Рабочая температура		Gross vehicle weight · Poids en charge du véhicule · Fahrzeug-Gesamtgewicht · Peso lordo del veicolo · Peso bruto vehiculo · Peso sobre o eixo dianteiro · Полный вес крана
	Lights · Les feux · Beleuchtung · Luci · Lucas · Faróis · Освещение		Weight on front axle · Poids sur l'essieu avant · Achslast Vorderachse · Peso sull'assale anteriore · Peso eje delantero · Peso sobre o eixo dianteiro · Нагрузка на переднюю ось
	Crane / Crane in standard configuration · Grue / Grue en configuration standard · Kran / Kran in Standardkonfiguration · Gru / Gru in configurazione standard · Grúa / Grúa configuración estándar · Guindaste / Guindaste na configuração padrão · Кран/кран в стандартной комплектации		Weight on rear axle · Poids sur l'essieu arrière · Achslast Hinterachse · Peso sull'assale posteriore · Peso eje trasero · Peso sobre o eixo traseiro · Нагрузка на заднюю ось
	Crane without counterweight · Grue sans contrepoids · Kran ohne Gegengewicht · Gru senza contrappeso · Grúa sin contrapeso · Guindaste sem contrapeso · Кран без противовесов		No. of sheaves · Nombre de poulies · Anzahl Rollen · Numero di puleghe · N° poleas · N° roldanas · Кол-во шкивов
	Rated weight on hook block · Poids nominal sur crochet moufle · Nenngewicht an Unterflasche · Carco nominale al bozzello · Carga nominal en gancho · Peso nominal no moitão · Ном. нагрузка на крюкоблок		Single hook · Crochet simple · Haken einzeln · Gancho singolo · Gancho simple · Gancho simples · Однорогий крюк
	No. of lines · Nombre de lignes · Anzahl Seile · Numero di taglie · N° ramales · N° cabos · Кол-во тросов		Electric circuit · Circuit électrique · Elektrische Anlage · Circuito elettrico · Circuito eléctrico · Extensão da lança · Гидропневматический тормоз
	Single hook · Crochet simple · Haken einzeln · Gancho singolo · Gancho simple · Gancho simples · Однорогий крюк		Differential lock · Blocage du différentiel · Differenzialsperre · Blocco differenziale · Bloqueo diferencial · Bloqueo do diferencial · Блокировка дифференциала

HIGHLIGHTS

RT 1080 L

ATOUS MAJEURS · PRODUKTMERKMALE · CARATTERISTICHE PRINCIPALI ·
CARACTERÍSTICAS DESTACADAS · DESTAQUES · ОСНОВНЫЕ ФУНКЦИИ

- ▶ Rated capacity · Capacité nominale · Nenntraglast · Capacità nominale · Capacidad nominal · Capacidade nominal ·
Номинальная грузоподъемность:
80 t at 2.5 m working radius
80 t à 2,5 m de portée
80 t bei 2,5 m Ausladung
80 t a 2,5 m dall'asse di rotazione
80 t a 2,5 m radio de trabajo
80 t a 2,5 m raio de operação
80 т рабочий радиус на 2,5 м
- ▶ Maximum main boom length · Longueur max. de flèche · Max. Auslegerlänge · Lunghezza massima braccio telescopico ·
Longitud de pluma máx. · Comprimento máximo da lança · Максимальная длина стрелы:
42,1 m
- ▶ Maximum tip height · Hauteur max. de déversement · Max. Rollenhöhe · Altezza di testa massima · Altura de la punta máx. ·
Altura da ponta máx. · Максимальная высота вершины:
45 m
- ▶ Maximum hook height · Hauteur max. au crochet · Max. Hakenhöhe · Altezza massima del gancio · Altura de gancho máxima ·
Altura máxima do gancho · Максимальная высота до крюка:
43 m



DIMENSIONS

RT 1080 L



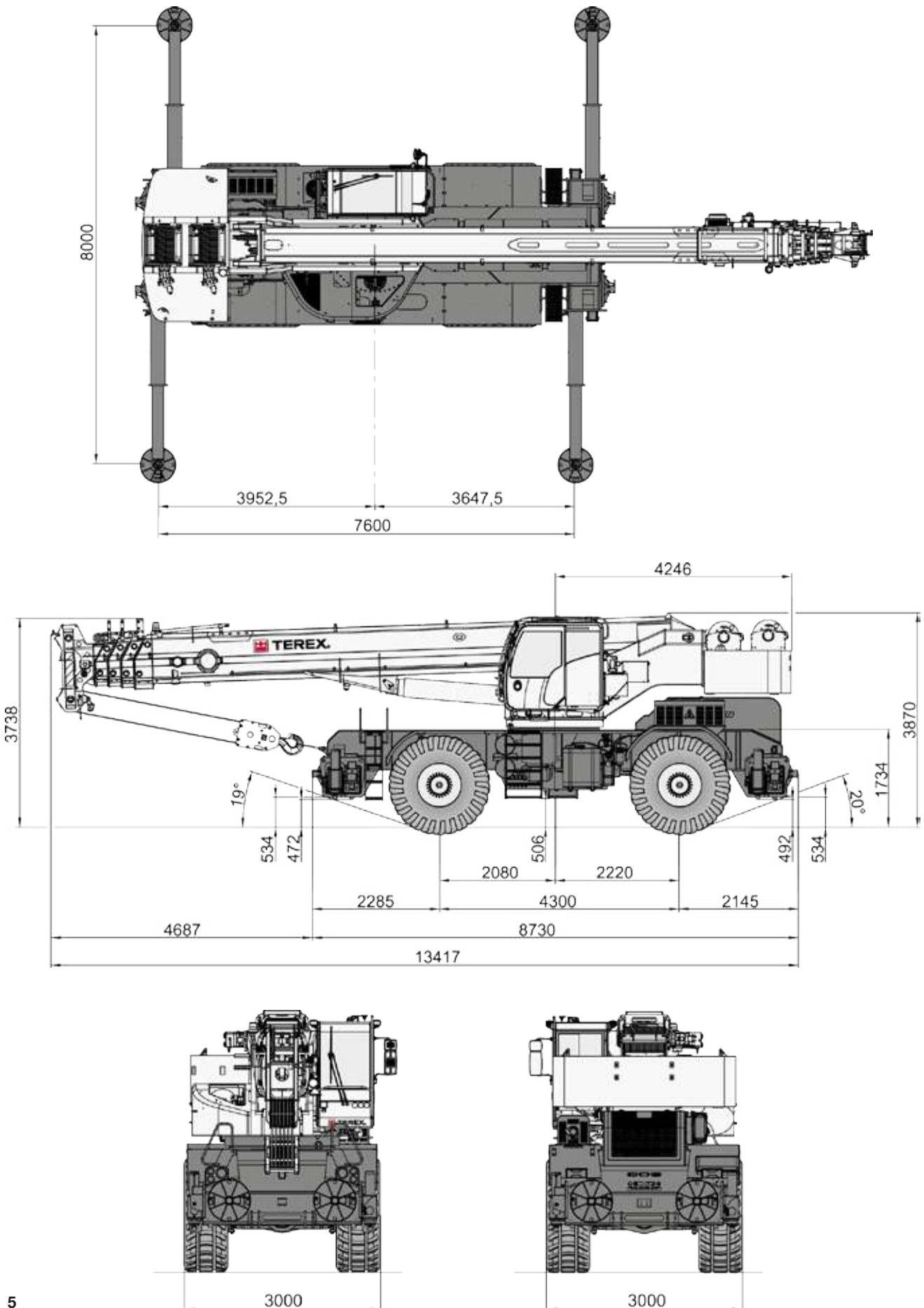





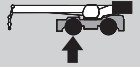

DIMENSIONS · ABMESSUNGEN · DIMENSIONI · DIMENSIONES ·
DIMENSÕES · РАЗМЕРЫ

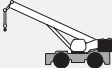

WEIGHTS

RT 1080 L

POIDS · GEWICHTE · PESI · PESOS · PESOS · BEC

				
	without hook block · sans crochet moufle · ohne Unterflasche · senza bozzello · sin gancho · sem moitão · п/ Крюкоблок	47 050 kg	22 800 kg	24 250 kg
Add / Subtract for main optional equipment · Supplément / retrait de poids pour équipement optionnel · Für optionale Ausstattung hinzufügen / abziehen · Da sommare a seconda dell'allestimento opzionale · Sumar / restar para equipamiento opcional principal · Acrescentar / subtrair para principais equipamentos opcionais · Добавить/вычесть для дополнительного оборудования				
	8 m stowed aside the boom · escamotable sur le côté de la flèche · seitlich am Ausleger verstaut · staffata a lato braccio · almacenado lateralmente a la pluma · guardada na lateral da lança · складываемая сбоку на главной стреле	+ 600 kg	+ 1050 kg	- 450 kg
	2 **	+ 830 kg	- 155 kg	+ 985 kg
	80 t*	+ 750 kg	+ 1860 kg	- 1100 kg
	40 t*	+ 485 kg	+ 1200 kg	- 718 kg
	40 t*	+ 485 kg	+ 1200 kg	- 718 kg
	12.5 t*	+ 255 kg	+ 633 kg	- 377 kg
	8 t*	+ 160 kg	+ 397 kg	- 237 kg

NOTE: Values are subject to 2% variation · REMARQUE : Les valeurs sont sujettes à une variation de 2% · HINWEIS: Werte können bis zu 2% abweichen ·
NOTA: I valori possono variare fino al 2% · NOTA: Valores sujetos a una variación del 2% · OBSERVAÇÃO: Valores sujeitos a 2% de variação ·
ПРИМЕЧАНИЕ. Значения даны с допуском +/- 2%

* Weight distribution calculated considering the hook block linked to the front shield of the machine · Répartition du poids calculée en considérant le crochet moufle connecté au panneau frontal de la machine · Berechnung der Gewichtsverteilung mit Hakenflasche am vorderen Rammschutz des Krans gesichert · Le distribuzioni dei pesi sono calcolate considerando il bozzello legato davanti al carro · Distribución de pesos calculada considerando el gancho asegurado al protector frontal · Distribuição de pesos calculada considerando o moitão ligado à proteção dianteira da máquina · Распределение нагрузки рассчитано для крана с крюкоблоком, закрепленном на переднем щите машины

** Weight includes rope · Le poids comprend le câble · Gewicht einschließlich Seile · I pesi includono la fune · El peso incluye soporte cabrestante · Peso inclui cabo · Вес включает вес троса

STEERING RADII

RT 1080 L

RAYON DE BRAQUAGE · LENKRADIEN · RAGGI DI STERZATA ·
RADIOS DE DIRECCIÓN · RAIOS DE GIRO · РАДИУСЫ ПОВОРОТОВ

**Two wheel steer · Deux roues directrices · Zweiradlenkung · Sterzata a due ruote ·
Dirección en dos ruedas · Direção em duas rodas · Поворот на двух колесах**

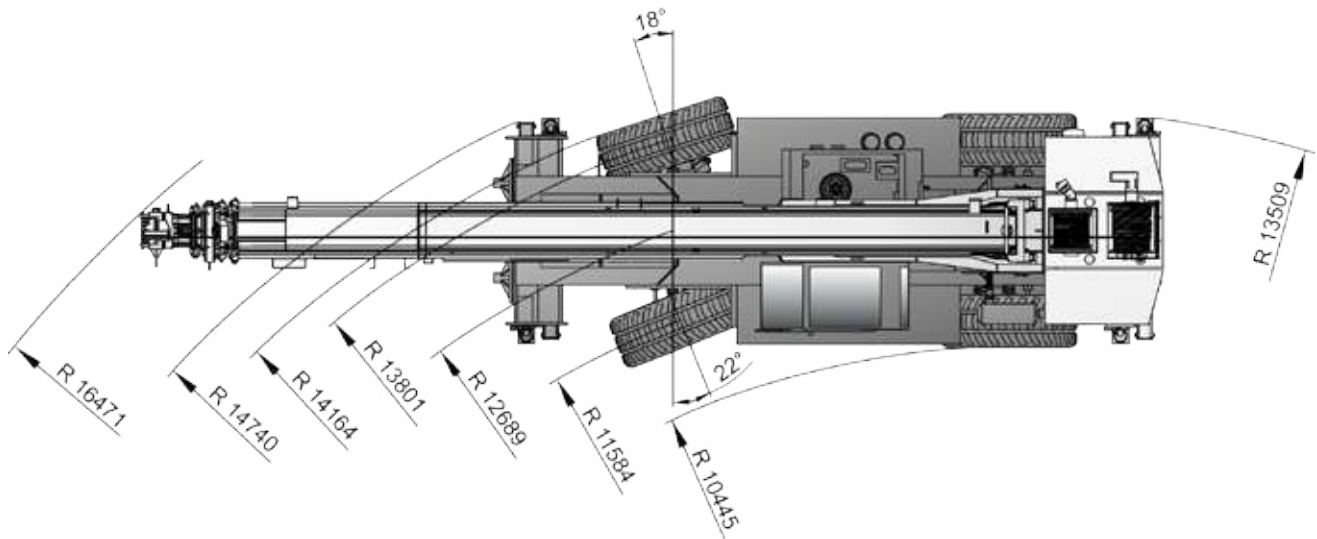

**Four wheel steer · Quatre roues directrices · Allradlenkung · Sterzata a quattro ruote ·
Dirección en cuatro ruedas · Direção em quatro rodas · Поворот на четырех колесах**

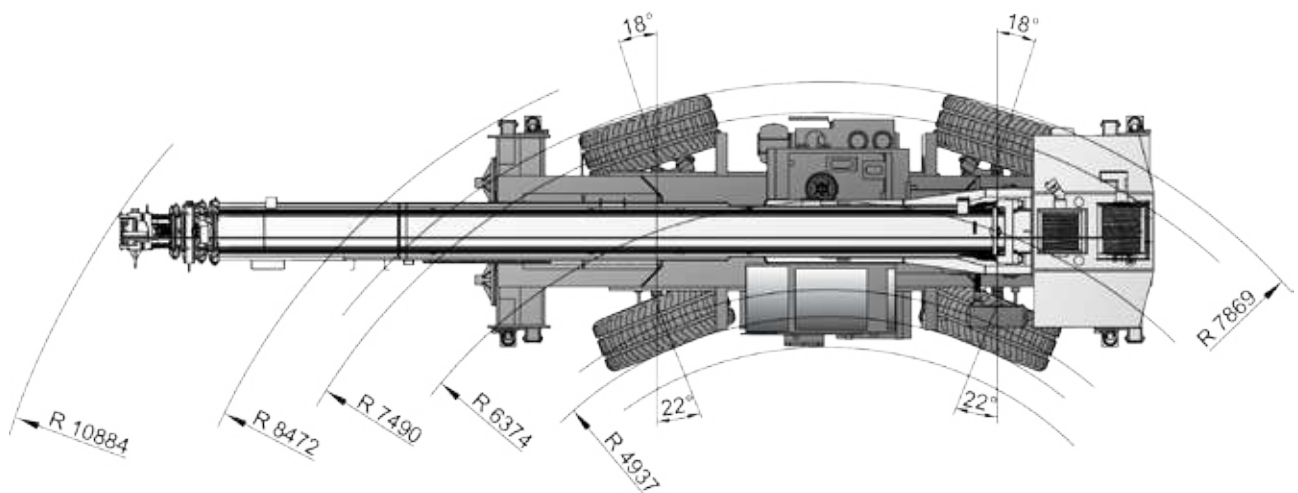

RANGE GRAPH

RT 1080 L

DIAGRAMME DE CHARGE · ARBEITSBEREICH · CAMPO DI PORTATA ·
 DIAGRAMA DE CARGA · GRÁFICO DE ALCANCE · ДИАГРАММА РАБОЧЕЙ ЗОНЫ

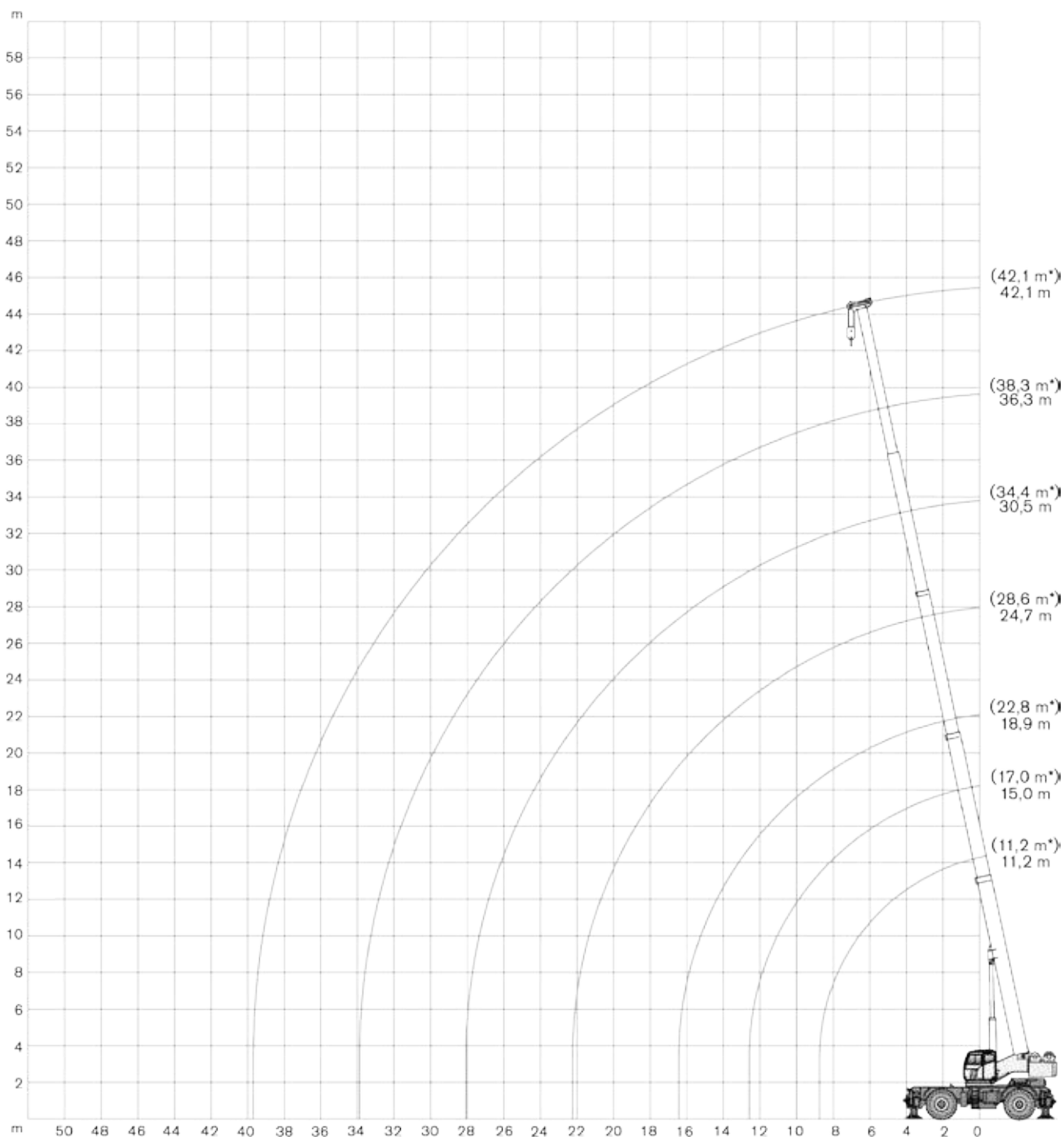
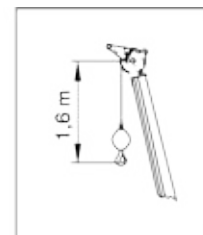
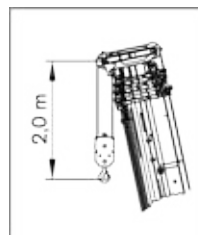

(* Mode 2)
 Mode 1

LOAD CHART

RT 1080 L

GRAPHIQUE DE CHARGE · TRAGLASTTABELLE · DIAGRAMMA DI CARICO ·
TABLA DE CARGA · TABELA DE CARGA · ТАБЛИЦА НАГРУЗОК

		8,9 t		7,60 x 8,0 m		360°		EUROPEAN STANDARD EN 13000											
		Mode 1							Mode 2										
		(m)	11,2	15,0	18,9	24,7	30,5	36,3	42,1			(m)	11,2	17,0	22,8	28,6	34,4	38,3	42,1
m	t	t	t	t	t	t	t	t	t	m	t	t	t	t	t	t	t	t	t
2,5	80,00	-	-	-	-	-	-	-	-	2,5	80,00	-	-	-	-	-	-	-	-
3,0	75,00	68,40	42,90	-	-	-	-	-	-	3,0	75,00	26,50	-	-	-	-	-	-	-
3,5	69,70	65,40	39,70	24,50	-	-	-	-	-	3,5	69,70	27,50	22,90	-	-	-	-	-	-
4,0	63,60	60,80	36,80	25,10	-	-	-	-	-	4,0	63,60	28,50	21,40	-	-	-	-	-	-
4,5	60,10	56,20	34,30	25,70	-	-	-	-	-	4,5	60,10	29,60	20,00	16,20	-	-	-	-	-
5,0	54,90	49,00	32,10	25,70	22,20	-	-	-	-	5,0	54,90	30,90	18,70	15,20	-	-	-	-	-
6,0	44,30	39,90	28,30	22,70	19,50	17,10	-	-	-	6,0	44,30	31,40	16,60	13,50	10,30	-	-	-	-
7,0	37,10	33,40	25,30	20,40	17,40	15,40	-	-	-	7,0	37,10	29,50	15,00	12,10	10,10	10,20	-	-	-
8,0	29,90	29,00	22,80	18,30	15,70	14,10	10,20	-	-	8,0	29,90	28,00	13,60	10,80	9,80	10,00	10,20	-	-
9,0	-	25,10	20,60	16,60	14,20	12,70	10,00	-	-	9,0	-	26,60	12,40	9,80	9,00	9,80	10,00	-	-
10,0	-	19,20	18,80	15,20	13,00	11,60	9,80	-	-	10,0	-	19,95	11,40	9,00	7,80	9,00	9,80	-	-
11,0	-	15,90	15,35	14,00	11,90	10,60	9,00	-	-	11,0	-	16,75	10,50	8,20	6,80	7,80	9,00	-	-
12,0	-	13,40	12,95	12,90	10,90	9,70	8,30	-	-	12,0	-	14,30	9,70	7,50	6,60	7,10	8,30	-	-
13,0	-	-	10,95	11,90	10,10	8,90	7,70	-	-	13,0	-	12,45	9,00	6,90	5,70	6,60	7,70	-	-
14,0	-	-	9,40	10,25	9,30	8,30	7,10	-	-	14,0	-	10,85	8,40	6,30	5,30	6,10	7,10	-	-
15,0	-	-	8,10	8,95	8,60	7,70	6,60	-	-	15,0	-	-	7,90	5,90	4,90	5,60	6,60	-	-
16,0	-	-	7,05	7,85	8,10	7,00	6,10	-	-	16,0	-	-	7,20	5,50	4,50	5,20	6,10	-	-
17,0	-	-	-	6,95	7,50	6,50	5,70	-	-	17,0	-	-	6,80	5,10	4,50	5,10	5,70	-	-
18,0	-	-	-	6,15	6,90	6,10	5,40	-	-	18,0	-	-	6,40	4,80	3,90	4,60	5,40	-	-
19,0	-	-	-	5,45	5,85	5,70	5,10	-	-	19,0	-	-	6,00	4,50	3,70	4,50	5,10	-	-
20,0	-	-	-	4,75	5,20	5,30	4,80	-	-	20,0	-	-	5,70	4,20	3,50	4,00	4,80	-	-
21,0	-	-	-	4,25	4,70	5,00	4,50	-	-	21,0	-	-	-	4,00	3,20	3,80	4,50	-	-
22,0	-	-	-	3,75	4,20	4,70	4,20	-	-	22,0	-	-	-	3,70	3,00	3,50	4,20	-	-
23,0	-	-	-	-	3,80	4,10	4,00	-	-	23,0	-	-	-	3,50	2,80	3,30	4,00	-	-
24,0	-	-	-	-	3,40	3,70	3,70	-	-	24,0	-	-	-	3,30	2,60	3,10	3,70	-	-
25,0	-	-	-	-	3,05	3,35	3,50	-	-	25,0	-	-	-	3,10	2,40	2,90	3,50	-	-
26,0	-	-	-	-	2,70	3,00	3,30	-	-	26,0	-	-	-	3,00	2,30	2,80	3,30	-	-
27,0	-	-	-	-	2,40	2,75	3,10	-	-	27,0	-	-	-	-	2,10	2,60	3,10	-	-
28,0	-	-	-	-	2,15	2,45	2,65	-	-	28,0	-	-	-	-	2,00	2,50	2,65	-	-
29,0	-	-	-	-	-	2,20	2,40	-	-	29,0	-	-	-	-	1,90	2,30	2,40	-	-
30,0	-	-	-	-	-	1,95	2,15	-	-	30,0	-	-	-	-	1,80	2,20	2,15	-	-
31,0	-	-	-	-	-	1,75	1,95	-	-	31,0	-	-	-	-	1,70	2,10	1,95	-	-
32,0	-	-	-	-	-	1,55	1,75	-	-	32,0	-	-	-	-	-	2,00	1,75	-	-
33,0	-	-	-	-	-	1,35	1,55	-	-	33,0	-	-	-	-	-	1,90	1,55	-	-
34,0	-	-	-	-	-	-	1,40	-	-	34,0	-	-	-	-	-	1,70	1,40	-	-
35,0	-	-	-	-	-	-	1,25	-	-	35,0	-	-	-	-	-	1,60	1,25	-	-
36,0	-	-	-	-	-	-	1,10	-	-	36,0	-	-	-	-	-	-	1,10	-	-
37,0	-	-	-	-	-	-	0,95	-	-	37,0	-	-	-	-	-	-	0,95	-	-
38,0	-	-	-	-	-	-	0,80	-	-	38,0	-	-	-	-	-	-	0,80	-	-
39,0	-	-	-	-	-	-	0,65	-	-	39,0	-	-	-	-	-	-	0,65	-	-
40,0	-	-	-	-	-	-	-	-	-	40,0	-	-	-	-	-	-	-	-	-

LOAD CHART

RT 1080 L

GRAPHIQUE DE CHARGE · TRAGLASTTABELLE · DIAGRAMMA DI CARICO ·
TABLA DE CARGA · TABELA DE CARGA · ТАБЛИЦА НАГРУЗОК

		8,9 t		7,60 x 5,30 m		360°		EUROPEAN STANDARD EN 13000									
		Mode 1							Mode 2								
	(m)	11,2	15,0	18,9	24,7	30,5	36,3	42,1		(m)	11,2	17,0	22,8	28,6	34,4	38,3	42,1
m	t	t	t	t	t	t	t	t	m	t	t	t	t	t	t	t	t
2,5	80,00	-	-	-	-	-	-	-	2,5	80,00	-	-	-	-	-	-	-
3,0	75,00	68,40	42,90	-	-	-	-	-	3,0	75,00	26,50	-	-	-	-	-	-
3,5	69,70	65,40	39,70	24,50	-	-	-	-	3,5	69,70	27,50	22,90	-	-	-	-	-
4,0	63,60	60,80	36,80	25,10	-	-	-	-	4,0	63,60	28,50	21,40	-	-	-	-	-
4,5	55,50	56,20	34,30	25,70	-	-	-	-	4,5	55,50	29,60	20,00	16,20	-	-	-	-
5,0	48,30	41,45	32,10	25,70	22,20	-	-	-	5,0	48,30	30,90	18,70	15,20	-	-	-	-
6,0	29,85	28,30	28,30	22,70	19,50	17,10	-	-	6,0	29,85	31,40	16,60	13,50	10,30	-	-	-
7,0	22,00	20,95	20,25	20,40	17,40	15,40	-	-	7,0	22,00	22,75	15,00	12,10	10,10	10,20	-	-
8,0	17,15	16,40	15,85	18,30	15,70	14,10	10,20	-	8,0	17,15	18,00	13,60	10,80	9,80	10,00	10,20	-
9,0	-	13,05	12,55	13,30	14,20	12,70	10,00	-	9,0	-	14,65	12,40	9,80	9,00	9,80	10,00	-
10,0	-	10,65	10,25	11,00	11,40	11,60	9,80	-	10,0	-	12,20	11,40	9,00	7,80	9,00	9,80	-
11,0	-	8,85	8,45	9,25	9,65	10,60	9,00	-	11,0	-	10,35	10,50	8,20	6,80	7,80	9,00	-
12,0	-	7,40	7,05	7,80	8,20	8,45	8,30	-	12,0	-	8,85	9,70	7,50	6,60	7,10	8,30	-
13,0	-	-	5,90	6,65	7,05	7,35	7,70	-	13,0	-	7,65	9,00	6,90	5,70	6,60	7,70	-
14,0	-	-	4,95	5,70	6,15	6,40	7,10	-	14,0	-	6,70	7,05	6,30	5,30	6,10	7,10	-
15,0	-	-	4,15	4,90	5,30	5,60	5,70	-	15,0	-	-	6,20	5,90	4,90	5,60	5,70	-
16,0	-	-	3,40	4,20	4,65	4,85	5,00	-	16,0	-	-	5,45	5,50	4,50	5,20	5,00	-
17,0	-	-	-	3,55	4,00	4,30	4,45	-	17,0	-	-	4,85	5,10	4,50	5,10	4,45	-
18,0	-	-	-	3,05	3,50	3,75	3,95	-	18,0	-	-	4,30	4,80	3,90	4,60	3,95	-
19,0	-	-	-	2,65	3,05	3,30	3,55	-	19,0	-	-	3,85	4,50	3,70	3,80	3,55	-
20,0	-	-	-	2,20	2,65	2,90	3,10	-	20,0	-	-	3,45	3,65	3,50	3,40	3,10	-
21,0	-	-	-	1,85	2,30	2,55	2,75	-	21,0	-	-	-	3,25	3,20	3,05	2,75	-
22,0	-	-	-	1,55	1,95	2,25	2,45	-	22,0	-	-	-	2,95	3,00	2,70	2,45	-
23,0	-	-	-	-	1,70	1,95	2,15	-	23,0	-	-	-	2,70	2,80	2,45	2,15	-
24,0	-	-	-	-	1,40	1,70	1,90	-	24,0	-	-	-	2,40	2,60	2,15	1,90	-
25,0	-	-	-	-	1,20	1,45	1,65	-	25,0	-	-	-	2,15	2,40	1,90	1,65	-
26,0	-	-	-	-	0,95	1,25	1,40	-	26,0	-	-	-	1,90	2,30	1,70	1,40	-
27,0	-	-	-	-	0,75	1,05	1,20	-	27,0	-	-	-	-	1,85	1,50	1,20	-
28,0	-	-	-	-	0,55	0,85	1,05	-	28,0	-	-	-	-	1,65	1,30	1,05	-
29,0	-	-	-	-	-	0,65	0,85	-	29,0	-	-	-	-	1,45	1,15	0,85	-
30,0	-	-	-	-	-	0,50	0,70	-	30,0	-	-	-	-	1,30	0,95	0,70	-
31,0	-	-	-	-	-	0,35	0,55	-	31,0	-	-	-	-	1,15	0,80	0,55	-
32,0	-	-	-	-	-	-	0,40	-	32,0	-	-	-	-	-	0,70	0,40	-
33,0	-	-	-	-	-	-	-	-	33,0	-	-	-	-	-	0,55	-	-
34,0	-	-	-	-	-	-	-	-	34,0	-	-	-	-	-	0,40	-	-
35,0	-	-	-	-	-	-	-	-	35,0	-	-	-	-	-	0,30	-	-
36,0	-	-	-	-	-	-	-	-	36,0	-	-	-	-	-	-	-	-

LOAD CHART

RT 1080 L

GRAPHIQUE DE CHARGE · TRAGLASTTABELLE · DIAGRAMMA DI CARICO ·
TABLA DE CARGA · TABELA DE CARGA · ТАБЛИЦА НАГРУЗОК

		8,9 t		7,60 x 2,70 m		360°		EUROPEAN STANDARD EN 13000												
		Mode 1							Mode 2											
		(m)	11,2	15,0	18,9	24,7	30,5	36,3	42,1			(m)	11,2	17,0	22,8	28,6	34,4	38,3	42,1	
		m	t	t	t	t	t	t	t	m	t	t	t	t	t	t	t	t	t	
3,0			37,50	33,60	33,30	-	-	-	-	3,0	37,50	26,50	22,90	16,20	10,30	8,55	6,70			
3,5			29,05	25,90	25,70	24,50	-	-	-	3,5	29,05	27,50	22,90	16,20	10,30	8,55	6,70			
4,0			23,45	20,85	20,85	21,10	-	-	-	4,0	23,45	23,10	21,40	16,20	10,30	8,55	6,70			
4,5			19,50	17,35	17,10	17,40	-	-	-	4,5	19,50	19,15	20,00	16,20	10,30	8,55	6,70			
5,0			16,40	15,30	14,45	14,65	14,35	-	-	5,0	16,40	16,30	16,25	15,20	10,30	8,55	6,70			
6,0			12,05	11,30	10,70	11,05	11,05	10,60	-	6,0	12,05	12,40	12,45	13,50	10,30	8,55	6,70			
7,0			9,20	8,55	8,10	8,60	8,60	8,35	-	7,0	9,20	9,65	9,90	9,85	10,10	8,55	6,70			
8,0			7,20	6,60	6,25	6,85	6,90	6,85	6,70	8,0	7,20	7,75	8,00	8,05	7,85	6,95	6,70			
9,0			-	5,15	4,80	5,50	5,65	5,55	5,45	9,0	-	6,30	6,60	6,70	6,60	5,80	5,45			
10,0			-	4,00	3,70	4,40	4,75	4,60	4,50	10,0	-	5,20	5,50	5,65	5,50	4,85	4,50			
11,0			-	3,15	2,80	3,50	3,90	3,85	3,75	11,0	-	4,30	4,60	4,75	4,75	4,10	3,75			
12,0			-	2,30	2,05	2,80	3,20	3,25	3,15	12,0	-	3,60	3,90	4,00	4,05	3,45	3,15			
13,0			-	-	1,45	2,15	2,55	2,70	2,60	13,0	-	3,00	3,30	3,40	3,50	2,95	2,60			
14,0			-	-	0,95	1,65	2,05	2,25	2,15	14,0	-	2,45	2,80	2,90	3,00	2,50	2,15			
15,0			-	-	0,50	1,20	1,65	1,90	1,80	15,0	-	-	2,35	2,50	2,60	2,15	1,80			
16,0			-	-	-	0,85	1,25	1,50	1,50	16,0	-	-	1,95	2,10	2,20	1,85	1,50			
17,0			-	-	-	0,50	0,95	1,20	1,20	17,0	-	-	1,60	1,80	1,90	1,55	1,20			
18,0			-	-	-	-	0,65	0,90	0,95	18,0	-	-	1,30	1,50	1,60	1,25	0,95			
19,0			-	-	-	-	-	0,65	0,75	19,0	-	-	1,10	1,25	1,35	1,00	0,75			
20,0			-	-	-	-	-	-	0,40	0,55	20,0	-	-	0,85	1,00	1,15	0,80	0,55		
21,0			-	-	-	-	-	-	-	-	21,0	-	-	-	0,80	0,90	0,60	-		
22,0			-	-	-	-	-	-	-	-	22,0	-	-	-	0,60	0,75	0,40	-		
23,0			-	-	-	-	-	-	-	-	23,0	-	-	-	0,45	0,55	-	-		
24,0			-	-	-	-	-	-	-	-	24,0	-	-	-	-	0,40	-	-		
25,0			-	-	-	-	-	-	-	-	25,0	-	-	-	-	-	-	-		

RANGE GRAPH

RT 1080 L



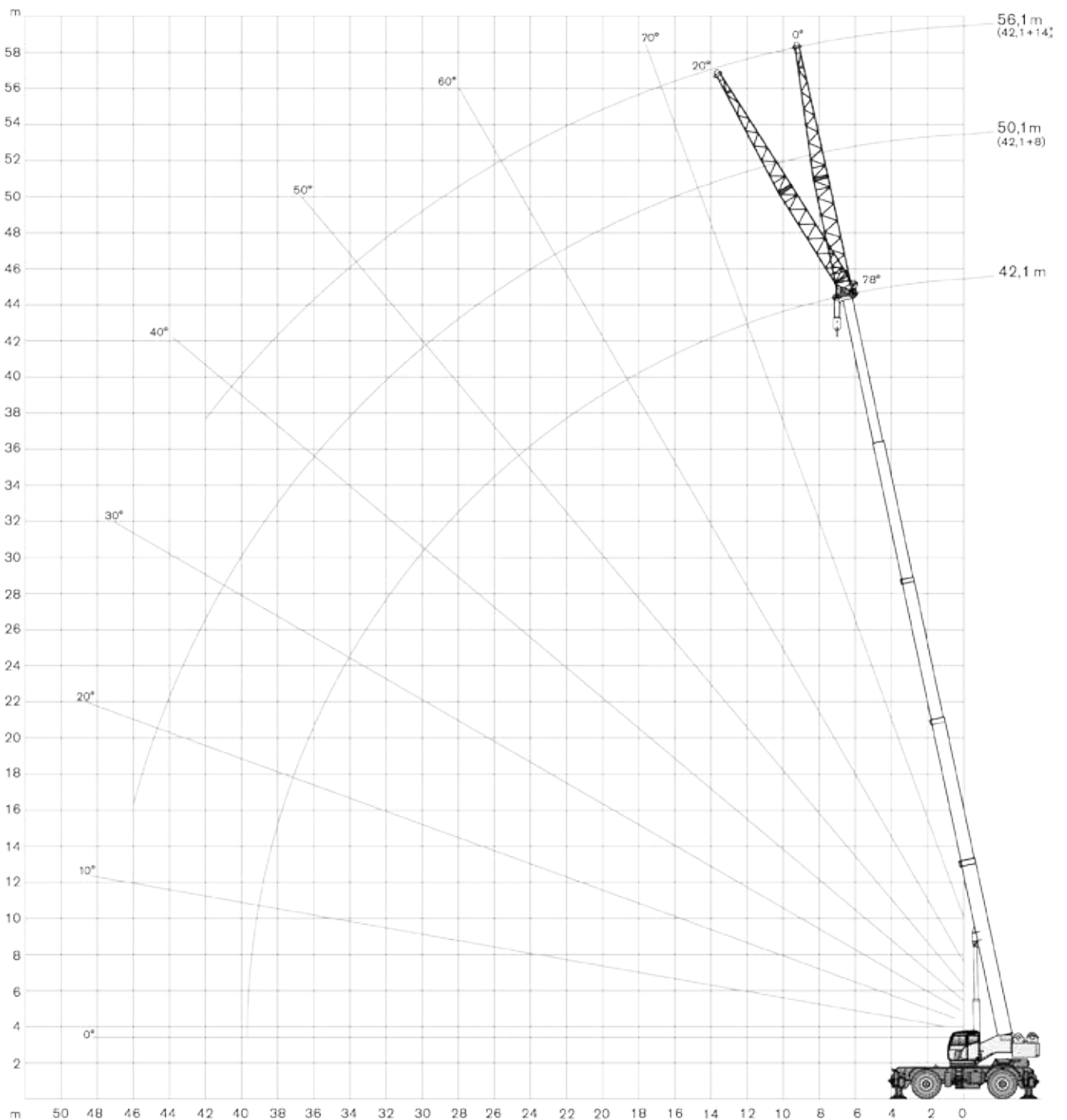
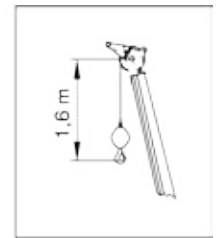
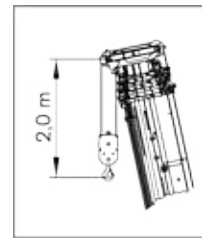





DIAGRAMME DE CHARGE · ARBEITSBEREICH · CAMPO DI PORTATA ·
 DIAGRAMA DE CARGA · GRÁFICO DE ALCANCE · ДИАГРАММА РАБОЧЕЙ ЗОНЫ



LOAD CHART

RT 1080 L

GRAPHIQUE DE CHARGE · TRAGLASTTABELLE · DIAGRAMMA DI CARICO ·
TABLA DE CARGA · TABELA DE CARGA · ТАБЛИЦА НАГРУЗОК

    EUROPEAN STANDARD EN 13000							
		 42,1 m					
 m		8 m		14 m		 m	
		0°	20°	0°	20°		
		t	t	t	t		
8,0		6,50	-	-	-	8,0	
9,0		6,20	-	-	-	9,0	
10,0		5,90	-	3,30	-	10,0	
11,0		5,60	3,10	3,15	-	11,0	
12,0		5,30	3,00	3,00	-	12,0	
13,0		5,05	2,95	2,80	-	13,0	
14,0		4,80	2,90	2,70	1,60	14,0	
15,0		4,55	2,85	2,60	1,55	15,0	
16,0		4,30	2,80	2,50	1,50	16,0	
17,0		4,10	2,75	2,40	1,50	17,0	
18,0		3,90	2,70	2,30	1,45	18,0	
19,0		3,60	2,65	2,20	1,45	19,0	
20,0		3,30	2,60	2,10	1,40	20,0	
21,0		3,00	2,45	2,00	1,40	21,0	
22,0		2,75	2,30	1,90	1,35	22,0	
23,0		2,40	2,15	1,80	1,30	23,0	
24,0		2,05	2,05	1,75	1,30	24,0	
25,0		1,85	1,80	1,65	1,25	25,0	
26,0		1,65	1,60	1,60	1,25	26,0	
27,0		1,45	1,45	1,50	1,15	27,0	
28,0		1,30	1,30	1,40	1,10	28,0	
29,0		1,20	1,15	1,35	1,05	29,0	
30,0		1,10	1,00	1,30	1,05	30,0	
31,0		1,00	0,85	1,10	0,90	31,0	
32,0		0,90	0,70	0,90	0,85	32,0	
33,0		0,80	0,65	0,75	0,80	33,0	
34,0		0,75	0,60	0,70	0,75	34,0	
35,0		0,70	0,55	0,65	0,70	35,0	
36,0		0,70	0,50	0,60	0,65	36,0	
37,0		0,65	0,50	0,55	0,60	37,0	
38,0		0,60	0,50	0,50	0,55	38,0	
39,0		0,50	0,50	0,45	0,50	39,0	
40,0		-	-	0,40	0,45	40,0	
41,0		-	-	0,35	0,40	41,0	
42,0		-	-	0,30	0,35	42,0	

LOAD CHART

RT 1080 L

GRAPHIQUE DE CHARGE · TRAGLASTTABELLE · DIAGRAMMA DI CARICO ·
TABLA DE CARGA · TABELA DE CARGA · ТАБЛИЦА НАГРУЗОК

		8,9 t				2 km/h		EUROPEAN STANDARD EN 13000			
		Mode 1						Mode 2			
		11,2 m	15,0 m	18,9 m	24,7 m			11,2 m	17,0 m	22,8 m	28,6 m
m	t	t	t	t	t	m	t	t	t	t	t
3,0	18,10	17,70	17,50	-	-	3,0	18,10	19,00	-	-	-
3,5	16,10	15,60	15,40	16,10	-	3,5	16,10	16,90	17,20	-	-
4,0	14,40	13,90	13,70	14,30	-	4,0	14,40	15,10	15,50	-	-
4,5	12,90	12,40	12,20	12,80	-	4,5	12,90	13,60	14,00	14,20	-
5,0	11,60	11,20	10,90	11,60	-	5,0	11,60	12,40	12,70	13,00	-
6,0	9,50	9,10	8,80	9,50	-	6,0	9,50	10,30	10,60	10,90	-
7,0	7,90	7,50	7,20	7,90	-	7,0	7,90	8,70	9,00	9,20	-
8,0	6,50	6,10	5,90	6,60	-	8,0	6,50	7,40	7,70	7,90	-
9,0	-	5,00	4,70	5,50	-	9,0	-	6,30	6,70	6,90	-
10,0	-	4,10	3,80	4,50	-	10,0	-	5,30	5,80	6,00	-
11,0	-	3,30	3,10	3,80	-	11,0	-	4,60	4,90	5,20	-
12,0	-	2,60	2,40	3,10	-	12,0	-	3,90	4,30	4,50	-
13,0	-	-	1,80	2,60	-	13,0	-	3,30	3,70	4,00	-
14,0	-	-	1,30	2,10	-	14,0	-	2,80	3,30	3,50	-
15,0	-	-	0,90	1,60	-	15,0	-	-	2,80	3,00	-
16,0	-	-	0,50	1,20	-	16,0	-	-	2,40	2,70	-
17,0	-	-	-	0,90	-	17,0	-	-	2,10	2,30	-
18,0	-	-	-	0,60	-	18,0	-	-	1,80	2,00	-
19,0	-	-	-	-	-	19,0	-	-	1,50	1,70	-
20,0	-	-	-	-	-	20,0	-	-	1,20	1,50	-
21,0	-	-	-	-	-	21,0	-	-	-	1,20	-
22,0	-	-	-	-	-	22,0	-	-	-	1,00	-
23,0	-	-	-	-	-	23,0	-	-	-	0,80	-
24,0	-	-	-	-	-	24,0	-	-	-	0,60	-
25,0	-	-	-	-	-	25,0	-	-	-	0,40	-
26,0	-	-	-	-	-	26,0	-	-	-	0,30	-
27,0	-	-	-	-	-	27,0	-	-	-	-	-





TECHNICAL SPECIFICATIONS

RT 1080 L

SPÉCIFICATIONS TECHNIQUES · TECHNISCHE DATEN · SPECIFICA TECNICA · ESPECIFICACIÓN TECNICA · ESPECIFICAÇÕES TÉCNICAS · ТЕХНИЧЕСКИЕ ХАРАКТЕРИСТИКИ







Boom

Flèche · Ausleger · Braccio · Pluma · Lança · Стрела

	5 sections · 5 segments · 5 Segmente · 5 sezioni · 5 secciones · 5 seções · 5 секции	
	Dual mode · Dual mode · Mode double · Dualmodus · Doppia modalità · Modo dual · Modo duplo · Два режима	
	Min. / Max. · Min / Max · Min. / Max. · Min. / Max. · Min. / Máx. · Min. / Máx. · Мин. / Макс.	11.2 m / 42.1 m
	Max. main boom · Flèche principale max. · Hauptausleger, max. · Max. braccio principale · Máx. pluma principal · Máx. lança principal · Макс. главной стрелы	45 m
	Boom luffing angle range (min. / max.) · Plage angulaire de relevage de la flèche (min. / max.) · Winkelstellung des Auslegers (min. / max.) · Angolo di brandeggio (min. / max.) · Ângulos de elevación de la pluma (min. / máx.) · Variação angular da articulação da lança (min. / máx.) · Диапазон изменения угла вылета стрелы (мин. / макс.)	-2° / +78°
	Boom raising / lowering time⁽¹⁾ · Durée de relevage / abaissement de la flèche ⁽¹⁾ · Ausleger Heben / Senken ⁽¹⁾ · Tempo di sollevamento / abbassamento braccio ⁽¹⁾ · Tiempo de elevación / descenso de la pluma ⁽¹⁾ · Tempo de elevação / abaixamento da lança ⁽¹⁾ · Время подъема/опускания стрелы ⁽¹⁾	75 s / 84 s
	Boom extension / retraction time⁽¹⁾ · Durée d'extension / rétraction de la flèche ⁽¹⁾ · Ausleger Ausfahren / Einfahren ⁽¹⁾ · Tempo di estensione / retrazione del braccio ⁽¹⁾ · Tiempo de extensión / retracción de la pluma ⁽¹⁾ · Tempo de alongamento / retração da lança ⁽¹⁾ · Время выдвижения/втягивания секций стрелы ⁽¹⁾	149 s / 155 s

Hoist

Treuil · Hubwerk · Argano e fune · Cabrestante · Guincho · Подъем

	Hydraulic motor · Moteur hydraulique · Hydromotor · Motore idraulico · Motor hidráulico · Motor hidráulicos · Гидравлический двигатель	
	Rope roller device · Tendeur de câble · Seilspannvorrichtung · Dispositivo pressafune · Sistema de tensado de cable · Sarrilho dos cabos · Направляющий ролик троса	
	Normally engaged brake · Frein serré normalement · Bremse im Normalzustand aktiviert · Freno normalmente inserito · Freno activado en estado normal · Freio normalmente aplicado · Нормально закрытый тормоз	
	2 speeds · 2 vitesses · 2 Geschwindigkeiten · 2 velocità · 2 velocidades · 2 velocidades · 2 скорости	
	Max.⁽¹⁾ · Max. ⁽¹⁾ · Max. ⁽¹⁾ · Max. ⁽¹⁾ · Máx. ⁽¹⁾ · Máx. ⁽¹⁾ · Макс. ⁽¹⁾	80 m/min.
	Rotational resistant · Faible torsion · Drehungsarm · Antirotazione · Antirotación · Anti-rotação · Антиротационный	
		18 mm
		220 m
	Permissible line pull · Traction du câble admissible · Max. Seilzug · Tiro massimo ammissibile · Tracción de cable admisible · Tração máxima admissível · Макс. нагр. на трос	63 kN



TECHNICAL SPECIFICATIONS

RT 1080 L

SPÉCIFICATIONS TECHNIQUES · TECHNISCHE DATEN · SPECIFICA TECNICA · ESPECIFICACIÓN TECNICA · ESPECIFICAÇÕES TÉCNICAS · ТЕХНИЧЕСКИЕ ХАРАКТЕРИСТИКИ





Upper Structure

Tourelle · Oberwagen · Superestructura · Sovrastruttura · Estrutura superior · Верхняя надстройка

		8.9 t
	Non stop · Rotation libre · Unbegrenzt drehbar · Senza fine · Sin fin · Sem fim · Безостановочн Maximum speed⁽¹⁾ · Vitesse maximale ⁽¹⁾ · Max. Drehgeschwindigkeit ⁽¹⁾ · Velocità massima ⁽¹⁾ · Velocidad máxima ⁽¹⁾ · Velocidade máxima ⁽¹⁾ · Максимальная скорость ⁽¹⁾	360° 1.1 rpm
	Hydraulic motor · Moteur hydraulique · Hydromotor · Motore idraulico · Motor hidráulico · Motor hidráulico · Гидравлический двигатель Planetary reducer · Réducteur planétaire · Planetenuntersetzung · Riduttore epicicloidale · Reductor planetario · Redutor planetário · Планетарный редуктор	

Cab and Controls

Cabine et commandes · Kabine und Steuerung · Cabina e comandi · Cabina y controles ·
Cabine e controles · Кабина и органы управления

	S-pace cab: Sliding door · Porte coulissante · Schiebetür · Porta scorrevole · Puerta deslizante · Porta corrediça · Раздвижная дверь Wide visibility · Visibilité optimale · Optimale Sichtverhältnisse · Ampia visibilità · Amplia visibilidad · Ampla visibilidade · Идеальный обзор Front and upper window with windscreen wiper · Essuie-glace pour pare-brise avant et lucarne de toit · Scheibenwischer für Frontscheibe und Dachfenster · Finestrino anteriore e superiore con tergicristalli · Luna frontal y superior con limpiaparabrisas · Janelas dianteira e superior com limpador de pára-brisa · Стеклоочистители переднего и верхнего окон Upper windows can be opened · Lucarne de toit ouvrante · Dachfenster zum Öffnen · Possibilità di apertura del finestrino superiore · Lunas superiores con apertura · A janela superior pode ser aberta · Открывающееся верхнее окно Tiltable cab · Cabine inclinable · Kabine neigbar · Cabina inclinabile · Cabina abatible · Cabine inclinável · Откидная кабина Fully adjustable seat onto shockproof suspensions · Siège à suspension pneumatique et entièrement réglable · Stoßgedämpfter Bedienerstz mit zahlreichen Einstellmöglich- keiten · Sedile interamente regolabile su sospensioni anti-shock · Asiento totalmente ajustable con suspensión anti-impacto · Assento totalmente ajustável com suspensões amortecidas · Полностью регулируемое сиденье на амортизирующей подвеске Equipped with tiltable arm rests with integrated hand controls for crane operation · Accoudoirs réglables avec éléments de commande intégrés pour le fonctionnement de la grue · Verstellbare Armlehnen mit integrierten Steuerelementen für den Kranbetrieb · Dotata di bracciolo inclinabile con comandi manuali integrati per il funzionamento della gru · Equipado con apoyabrazos abatible con controles integrados para operación de grúa · Equipado com apoio dos braços inclinável e controles de mão integrados para operação do guindaste · Откидные подлокотники с смонтированными в них пультами ручного управления краном Radio with CD player · Radio avec lecteur CD · Radio/CD · Autoradio con lettore CD · Radio-CD · Rádio com CD · Радиоприемник с плеером компакт-дисков в кабине Seat belts · Ceintures de sécurité · Sicherheitsgurte · Cinture di sicurezza · Cinturones de seguridad · Cintos de segurança · Ремни безопасности
	Climatized cab · Klimatisierte Kabine · Cabine climatisée · Cabina climatizzata · Cabina climatizada · Cabine climatizada · Кабина с климат-контролем Air-conditioning · Climatisation · Klimaanlage · Aria condizionata · Climatización · Ar condicionado · Кондиционер
	Electro-proportional joysticks · Manipulateurs électro-proportionnels · Elektroproportionale Joysticks · Joystick elettro-proporzionali · Joystick electroporcionados · Comandos electroporcionais · электропропорциональны й джойстик Load indicator with graphic interface · Indicateur de charge avec interface graphique · Lastanzeige mit grafischer Schnittstelle · Limitatore di carico con interfaccia grafica · Indicador de carga con interfaz gráfica · Indicador de carga com interface gráfica · Индикатор нагрузки с графическим интерфейсом
	Adjustable working light outside the cab · Einstellbarer Arbeitsscheinwerfer außen an Kabine · Phare de travail réglable à l'extérieur de la cabine · Faro di lavoro esterno alla cabina regolabile · Luz de trabajo ajustable en el exterior de la cabina · Farol de trabalho regulável fora da cabine · Регулируемое рабочее освещение снаружи кабины







TECHNICAL SPECIFICATIONS

RT 1080 L

SPÉCIFICATIONS TECHNIQUES · TECHNISCHE DATEN · SPECIFICA TECNICA · ESPECIFICACIÓN TECNICA · ESPECIFICAÇÕES TÉCNICAS · ТЕХНИЧЕСКИЕ ХАРАКТЕРИСТИКИ

Carrier

Châssis · Unterwagen · Carro · Chasis · Chassi · Шасси

	Cummins QSB6.7 Stage IIIA - Tier 3 Cummins QSB6.7 Stage IIIA - Tier 3 · Cummins QSB6.7 Stage IIIA - Tier 3 · Cummins QSB6.7 Stage IIIA - Tier 3 · Cummins QSB6.7 Stage IIIA - Tier 3 · Cummins QSB6.7 Stage IIIA - Tier 3 · Шестицилиндровый двигатель Cummins QSB6.7 Stage IIIA - Tier 3	
	No. of cylinders · Nombre de cylindres · Zahl der Zylinder · Numero di cilindri · N° cilindros · N° de cilindros · кол-во цилиндров	6
	Rated power · Puissance nominale · Nennleistung · Potenza nominale · Potencia nominal · Potência nominal · Номинальная мощность	164 kW @ 2200 1/min.
	Maximum gross torque · Couple de rotation max. · Max. Drehmoment · Coppia massima · Par de fuerza máx. · Torque bruto máx. · Макс. общий вращающий момент	945 Nm @ 1500 1/min.
	Fuel tank capacity · Capacité du réservoir de carburant · Kraftstofftankvolumen · Capacità serbatoio carburante · Volumen depósito combustible · Capacidade do tanque · Емкость топливного бака	300 l
	6 x 6 with torque converter · 6 x 6 avec convertisseur de couple · 6 x 6 mit Drehmomentwandler · 6 x 6 con convertitore di coppia · 6 x 6 con convertidor de par · 6 x 6 com conversor de torque · 6 x 6 с гидротрансформатором	
	2 wheel drive in high range mode · 2 roues motrices en mode haute gamme · Zweiradantrieb in hoher Fahrstufe · 2 ruote motrici in modalità sbraccio elevato · Tracción a 2 ruedas en modo de velocidades largas · Tração em 2 rodas em alta velocidade · привод на 2 колеса в повышенном диапазоне	
	4 wheel drive in low range mode · 4 roues motrices en mode basse gamme · Vierradantrieb in niedriger Fahrstufe · 4 ruote motrici in modalità sbraccio ridotto · Tracción a 4 ruedas en modo de velocidades cortas · Tração nas 4 rodas em baixa velocidade · привод на 4 колеса в низком диапазоне	
	Front wheel steering · Roues avant directrices · Vorderachslenkung · Sterzata a due ruote anteriori · Dirección en las ruedas delanteras · Manobra com as rodas dianteiras · Рулевое управление передними колесами	
	Four wheel steering concentric · Direction toutes roues · Allradlenkung · Sterzata a quattro ruote concentrica · Dirección en las cuatro ruedas, concéntrica · Manobras concéntricas com as quatro rodas · Режим рулевого управления четырьмя колесами в режиме «концентрический ход»	
	Four wheel steering crab · Marche en crabe toutes roues · Hundegang · Sterzata a quattro ruote a granchio · Dirección en las cuatro ruedas, modo cangrejo · Translação lateral com as quatro rodas · Режим рулевого управления четырьмя колесами в режиме «крабовый ход»	
	Two piston pumps · Double pompe à piston · Zwei Kolbenpumpen · Due pompe a pistoni · Bombas de dos pistones · Duas bombas de pistão · Два поршневых насоса	
	One double gear pump · Double pompe à engrenage · Doppelzahnradpumpe · Pompa doppia ad ingranaggi · Bomba de doble engranaje · Bomba de engrenagem dupla · Спаренный насос привода	
		24 V
	Rear axle differential lock · Blocage du différentiel de l'essieu arrière · Hinterachs-Differenzialsperre · Blocco differenziale assale posteriore · Bloqueo diferencial eje trasero · Bloqueio do diferencial do eixo traseiro · Блокировка дифференциала задней оси	

TECHNICAL SPECIFICATIONS

RT 1080 L

SPÉCIFICATIONS TECHNIQUES · TECHNISCHE DATEN · SPECIFICA TECNICA · ESPECIFICACIÓN TECNICA · ESPECIFICAÇÕES TÉCNICAS · ТЕХНИЧЕСКИЕ ХАРАКТЕРИСТИКИ

Vehicle Performance

Performances du véhicule · Fahrleistungen · Prestazioni veicolo · Prestaciones del vehículo · Desempenho do veículo · Характеристики автомобиля

	Max.⁽²⁾ · Max. ⁽²⁾ · Max. ⁽²⁾ · Max. ⁽²⁾ · Máx. ⁽²⁾ · Máx. ⁽²⁾ · Макс. ⁽²⁾	> 200 %
	Max.⁽²⁾ · Max. ⁽²⁾ · Max. ⁽²⁾ · Max. ⁽²⁾ · Máx. ⁽²⁾ · Máx. ⁽²⁾ · Макс. ⁽²⁾	29 km/h
	Min. / Max. · Min / Max · Min. / Max. · Min. / Max. · Min. / Máx. · Min. / Máx. · Мин. / Макс.	-20° / 45 °C



Tires

Pneumatiques · Bereifung · Pneumatici · Neumáticos · Pneus · Шины

	Earth moving style · Bande de roulement de type pour machine de terrassement · Grobes Profil, wie Erdbewegungsmaschinen · Per movimento terra · Para movimiento de tierra · Banda larga estilo terraplenagem · С широким протектором для движения по грунту	23.5
-----------------------------------------------------------------------------------	-----------------------------------------------------------------------------------------------------------------------------------------------------------------------------------------------------------------------------------------------------------------------------	------

Options

Options · Optionen · Opzioni · Opciones · Opcionais · Дополнительные опции

	Single sheave · Poulie unique · Einzelne Seilrolle · Puleggia singola · Una polea · Roldana simples · Один концевой шкив	
	Lattice type, side stowable · Flèche en treillis, escamotable sur le côté · Gittermast, seitlich verstaubar · Tralicciata, staffabile lateralmente · Tipo celosía, almacenable lateralmente · Jib treliçada, alojamento lateral · Доп. стрела решетчатая, укладываемая сбоку	8 m
	Lattice type, not side stowable · Flèche en treillis, non escamotable sur le côté · Gittermast, nicht seitlich verstaubt · Tralicciata, non riponibile lateralmente · Tipo celosía, sin almacenamiento lateral · Jib treliçada, sem alojamento na lateral · решетчатого типа, не складывается	14 m
	Angular offsets · Déports angulaires · Abwinkelbar · Inclinazioni · Inclinação · Desvío angular · Угловое смещение	0° / 20°
	Cameras · Caméras · Kameras · Telecamere · Cámaras · Câmeras · Камеры	
	Radio remote controller · Télécommande radio · Funkfernsteuerung · Telecomandi a radiofrequenza · Mando a distancia por radio · Controlo remoto via rádio · Дистанционный радио контроллер	
	Telematics · Télématique · Telematik · Telematica · Sistema telemático · Telemetria · Телематика	
	Hydraulic motor · Moteur hydraulique · Hydromotor · Motore idraulico · Motor hidráulico · Motor hidráulicos · Гидравлический двигатель	
	Rope roller device · Tendeur de câble · Seilspannvorrichtung · Dispositivo pressafune · Sistema de tensado de cable · Sarilho dos cabos · Направляющий ролик троса	
	Normally engaged brake · Frein serré normalement · Bremse im Normalzustand aktiviert · Freno normalmente inserito · Freno activado en estado normal · Freio normalmente aplicado · Нормально закрытый тормоз	

TECHNICAL SPECIFICATIONS

RT 1080 L

SPÉCIFICATIONS TECHNIQUES · TECHNISCHE DATEN · SPECIFICA TECNICA · ESPECIFICACIÓN TECNICA · ESPECIFICAÇÕES TÉCNICAS · ТЕХНИЧЕСКИЕ ХАРАКТЕРИСТИКИ

	2 speeds · 2 vitesses · 2 Geschwindigkeiten · 2 velocità · 2 velocidades · 2 velocidades · 2 скорости	
	Max.(1) · Max.(1) · Max.(1) · Max.(1) · Máx.(1) · Máx.(1) · Макс.(1)	80 m/min.
	Rotational resistant · Faible torsion · Drehungsarm · Antirotazione · Antirotación · Anti-rotação · Антиротационный	
		18 mm
		220 m
	Permissible line pull · Traction du câble admissible · Max. Seilzug · Tiro massimo ammissibile · Tracción de cable admisible · Tração máxima admissível · Макс. нагр. на трос	63 kN
	Outrigger control from the ground · Commande des stabilisateurs depuis le sol · Steuerung der Abstützungen vom Boden · Comando a terra per stabilizzatori · Control externo de los apoyos estabilizadores · Controle dos estabilizadores a partir do solo · Управление опорами с земли	
	Cummins QSB6.7 Stage V - Tier 4f · Cummins QSB6.7 Stage V - Tier 4f · Cummins QSB6.7 Stage V - Tier 4f · Cummins QSB6.7 Stage V - Tier 4f · Cummins QSB6.7 Stage V - Tier 4f · Шестицилиндровый двигатель Cummins QSB6.7 Stage V - Tier 4f	
	No. of cylinders · Nombre de cylindres · Zahl der Zylinder · Numero di cilindri · N° cilindros · N° de cilindros · кол-во цилиндров	6
	Rated power · Puissance nominale · Nennleistung · Potenza nominale · Potencia nominal · Potência nominal · Номинальная мощность	168 kW @ 2200 1/min.
	Maximum gross torque · Couple de rotation max. · Max. Drehmoment · Coppia massima · Par de fuerza máx. · Torque bruto máx. · Макс. общий вращающий момент	1186 Nm @ 1300 1/min.
	Fuel tank capacity · Capacité du réservoir de carburant · Kraftstofftankvolumen · Capacità serbatoio carburante · Volumen depósito combustible · Capacidade do tanque · Емкость топливного бака	300 l
	Kit for engine pre-warming · Kit pour préchauffage du moteur · Motorvorwärmung, Kit · Kit pre-riscaldamento motore · Kit de precalentamiento del motor · Kit de pré-aquecimento do motor · Комплект предварительного прогрева двигателя	
	Earth moving style · Bande de roulement de type pour machine de terrassement · Grobes Profil, wie Erdbewegungsmaschinen · Per movimento terra · Para movimiento de tierra · Banda larga estilo terraplenagem · С широким протектором для движения по грунту	26.5
	Spare wheel · Roue de secours · Reserverad · Ruota di scorta · Rueda de repuesto · Estepe · Запасное колесо	23.5 / 26.5

Emergency engine stop ·

Arrêt d'urgence du moteur · Motor-Notausschalter · Arresto di emergenza motore · Parada de emergencia del motor · Parada de emergência do motor · Устройство аварийного останова двигателя

Spark arrestor on exhaust pipe muffler* ·

Pare-étincelle sur le silencieux d'échappement* · Funkenfänger am Auspuff* · Parascintille su silenziatore scarico* · Parachispas en el silenciador del tubo de escape* · Placa protetora contra fagulhas no silencioso do escapamento* · Искрогаситель на глушителе выхлопной трубы*

Anemometer ·

Anémomètre · Windmesser · Anemometro · Anemómetro · Anemômetro · Анемометр

Rear towing hook ·

Crochet de remorquage arrière · Anhängerkupplung hinten · Gancio di traino posteriore · Enganche de remolque · Gancho traseiro de reboque · Крюк задний, буксировочный

Wooden box for cab protection in sea shipment ·

Caisson en bois pour protéger la cabine en cas de transport par voie maritime · Holzverpackung zum Schutz der Kabine beim Seetransport · Cassa in legno per protezione cabina per spedizione marittima · Caja de madera para proteger la cabina para el transporte marítimo · Caixa de madeira para proteção da cabine em transporte marítimo · Деревянная обшивка кабины для транспортировки морем

Removable parts disassembling and put into wooden box tied to the crane ·

Démontage des composants amovibles pour les conserver dans des caisses de bois arrimées à la grue · Bewegliche Teile demontieren und in Holzverpackung am Kran verstauen · Smontaggio parti asportabili e sistemate in cassa in legno legata alla gru · Desmontaje de las piezas desmontables y colocación en caja de madera fijada a la grúa · Desmontagem de peças removíveis e colocação em caixa de madeira amarrada ao guindaste · Разборка съемных частей и укладка их в деревянный ящик, закрепленный к крану

Anti-corrosive protective waxing for sea shipping ·

Cire de protection anticorrosive pour le transport par voie maritime · Antikorrosions-Schutzwachsüberzug für Seetransport · Ceratura protettiva per spedizione marittima · Aplicación de cera de protección para el transporte marítimo · Cera protetora anticorrosiva para transporte marítimo · Нанесение антикоррозийного защитного покрытия для транспортировки морем

Special customer paint of all boom elements ·

Peinture sur demande du client sur l'ensemble des éléments de flèche · Lackierung nach Kundenwunsch, sämtliche Auslegerbauteile · Verniciatura speciale su tutte le sezioni del braccio · Pintura especial en todas las secciones de la pluma · Pintura especial do cliente em todos os elementos da lança · Покраска всех секций стрелы крана в цвет заказчика

Special heavy painting suitable for corrosive environments ·









Peinture spéciale pour environnement hautement corrosifs · Sonderlackierung für korrosive Umgebung · Verniciatura speciale adatta ad ambienti corrosivi · Pintura especial para ambientes corrosivos · Pintura especial reforçada para ambientes corrosivos · Покраска специальной антикоррозийной краской

* only for engine Stage IIIA Tier 3 · uniquement pour moteur niveau IIIA Tier 3 · nur für Motoren gem. Stufe IIIA Tier 3 · solo per motore Stage IIIA Tier 3 · solo para motores Fase IIIA/Tier 3 · somente para motor Stage IIIA Tier 3 · только для двигателей стандарта IIIA Tier 3

TECHNICAL SPECIFICATIONS

RT 1080 L

SPÉCIFICATIONS TECHNIQUES · TECHNISCHE DATEN · SPECIFICA TECNICA · ESPECIFICACIÓN TECNICA · ESPECIFICAÇÕES TÉCNICAS · ТЕХНИЧЕСКИЕ ХАРАКТЕРИСТИКИ

							Standard	Optional
							Standard	Optional
			1	2			Standard	En option
							Serie	Option
							Standard	Opzionale
							Estándar	Opcional
							Padrão	Opcional
							Стандарт	Опция
80 t	6	12	•			•	•	
80 t	6	12	•		•			•
40 t	4	8	•			•		•
40 t	4	8	•		•			•
12.5 t	1	2	•	•		•		•
8 t	0	1	•	•		•		•

Note: refer to your local dealer for a full list of options.

(1) Indicative value only for reference.

(2) Standard crane in travelling configuration – value calculated with nominal tire radius and max power delivered to the wheels.

Remarque : Contactez votre concessionnaire pour obtenir la liste complète des options.

(1) Valeur indicative, pour référence uniquement.

(2) Grue standard en configuration de conduite – valeur calculée en fonction du rayon nominal du pneu et de la puissance max. transmise aux roues.

Hinweis: Ihr Händler vor Ort hält eine Übersicht aller verfügbarer Optionen bereit.

(1) Anhaltswert, dient nur als Referenz.

(2) Standardkran in verfahrbarer Konfiguration. Berechnung basiert auf Reifen-Nennradius und Maximalkraft, die auf die Räder wirkt.

Nota: Riferirsi al dealer di zona per un elenco completo degli opzionali.

(1) Valore indicativo solo come riferimento.

(2) Gru in versione standard ed in condizioni di marcia – valore calcolate in base al raggio nominale del pneumatico e alla massima possidenza alla ruota.

Nota: consulte la lista completa de opciones en su distribuidor local.

(1) Valor indicativo, sólo de referencia.

(2) Grúa estándar en configuración de marcha – valor calculado considerando el radio nominal del neumático y máxima potencia en las ruedas.

Nota: consulte no seu distribuidor local a relação completa de opcionais.

(1) Valor sugerido apenas para referência.

(2) Guindaste padrão em configuração de marcha – valor calculado considerando raio nominal dos pneus e potência máxima transmitida às rodas.

Примечание. Полный список всех доступных опций можно получить у местного дилера.

(1) Значения указаны только для справки.

(2) Значения даны для крана стандартной комплектации в режиме для перевозки и рассчитаны для шин нормального радиуса и максимального крутящего момента, передаваемого на колеса. крутящего момента, передаваемого на колеса.

NOTES TO LIFTING CAPACITY

RT 1080 L

NOTES RELATIVES À LA CAPACITÉ DE LEVAGE · HINWEIS ZU TRAGFÄHIGKEITEN · ANNOTAZIONI SULLE PORTATE · NOTAS SOBRE LA CAPACIDAD DE ELEVACIÓN · NOTAS SOBRE A CAPACIDADE DE IÇAMENTO · ПРИМЕЧАНИЯ ПО ГРУЗОПОДЪЕМНОСТИ

Weight of hook blocks and slings is considered part of the load and must be subtracted from the capacity ratings. Consult operation manual for further details.

Note: Data published herein is intended as a guideline only and shall not be construed to warrant applicability for lifting purposes. For actual crane operation refer to the computer charts and the operating manual, both of which are supplied with the crane.

Le poids du crochet-moufle et les élingues sont considérés comme entiers à la charge et doivent être soustraits des capacités. Pour plus de détails se référer au manuel d'instructions.

Remarque : Les présentes données sont publiées uniquement à titre indicatif et ne constituent en aucun cas une garantie d'aptitude aux opérations de levage.

Pour le fonctionnement de la grue, consulter les graphiques et le manuel d'instructions, fournis tous les deux avec la grue.

Gewichte der Unterflaschen sowie der Aufnahmemittel sind Bestandteile der Last und sind von den Tragfähigkeiten abzuziehen. Weitere Informationen entnehmen Sie bitte dem Bedienerhandbuch.

Hinweis: Die hier aufgeführten Daten dienen lediglich als Richtlinie und dürfen nicht für Hubeinsätze herangezogen werden. Für den tatsächlichen Betrieb des Kranes sind die Computertabellen und das Bedienerhandbuch zu Rate zu ziehen, die mit dem Kran ausgeliefert werden.

Il peso dei bozzelli e delle funi di imbracaggio viene considerato parte del carico e deve quindi essere sottratto dalle portate nominali. Per ulteriori dettagli sulla velocità del vento, consultare il manuale di istruzione della gru.

Nota: I dati riportati in questo prospetto sono forniti esclusivamente a titolo indicativo, pertanto non sono da ritenersi impegnativi ai fini dell'applicazione della garanzia sulle portate di sollevamento.

Per l'uso della gru occorre rispettare le tabelle originali e il manuale d'uso forniti in dotazione con la gru stessa.

Los pesos de los ganchos y las eslingas se consideran parte de la carga y tienen que ser restados de las capacidades nominales. Consulte el manual de instrucciones para más detalles.

Nota: Los datos publicados se proporcionan a título informativo, por tanto, no se consideraran vinculantes a los efectos de la garantía de la capacidad de elevación.

Para operar la grúa deben cumplirse las tablas originales y el manual de instrucciones suministrados con la grúa.

O peso dos moitões e eslingas é considerado parte da carga e tem de ser subtraído das capacidades nominais. Consultar manual de operação para outros detalhes.

Nota: Os dados publicados aqui destinam-se a simples orientação e não devem ser interpretados como garantia de aplicabilidade para fins de içamento.

Para a operação efetiva do guindaste, consulte as tabelas de computador e o manual de operação, ambos fornecidos com o guindaste.

Вес крюкоблока и строп считается частью груза и должен вычитаться из номинальных значений грузоподъемности. Подробности см. в руководстве по эксплуатации.

Примечание. Публикуемые данные даются только для справки и не должны использоваться при расчете нагрузки.

Расчетные данные для использования при эксплуатации крана приводятся в компьютерных таблицах и в руководстве по эксплуатации, поставляемыми вместе с краном.

NOTES

RT 1080 L

NOTES · NOTIZEN · NOTA · NOTAS · NOTAS ·
ПОМЕТЫ, КОММЕНТАРИИ, ПРИМЕЧАНИЯ

A large rectangular area with horizontal lines, intended for writing notes. The lines are evenly spaced and cover the majority of the page's width and height.

TEREX CRANES

Rough Terrain Cranes

Via Cassoletta, 76 – Fraz. Crespellano
40053 Valsamoggia (BO)
Italy

Ph: +39 051 6501011
Email: info.cranes@terex.com

Tower Cranes

Via delle Innovazioni, 17
33074 Fontanafredda (PN)
Italy

Ph: +39 0434 989111
Email: info.cranes@terex.com

December 2019. Product specifications and prices are subject to change without notice or obligation. The photographs and/or drawings in this document are for illustrative purposes only. Refer to the appropriate Operator's Manual for instructions on the proper use of this equipment. Failure to follow the corresponding Operator's Manual when using our equipment or to otherwise act responsibly may result in serious injury or death. The only warranty applicable to our equipment is the standard written warranty applicable to the particular product and sale and Terex makes no other warranty, express or implied. Products and services listed may be trademarks, service marks or trade-names of Terex Corporation and/or its subsidiaries in the USA and other countries. All rights are reserved. Terex, the Terex Crown design and Works For You are trademarks of Terex Corporation or its subsidiaries.

Décembre 2019. Les caractéristiques et prix des produits peuvent faire l'objet de modifications sans notification préalable. Les photographies ou dessins présentés dans ce document servent uniquement à des fins d'illustration. Pour connaître les instructions relatives à l'utilisation correcte de cet équipement, veuillez vous référer au manuel de l'utilisateur correspondant. Le non-respect du manuel d'utilisateur correspondant lors de l'utilisation de notre équipement ou des actes irresponsables risquent de provoquer de graves blessures, voire un décès. La seule garantie applicable à nos équipements est la garantie écrite standard applicable au produit et à la vente spécifiques. Terex ne délivre aucune autre garantie, expresse ou implicite. Les produits et les services mentionnés peuvent être des marques, des marques de service ou des appellations commerciales de Terex Corporation et/ou de ses filiales aux États-Unis et dans d'autres pays. Tous droits réservés. Terex, le design Terex Crown et Works For You sont des marques déposées de Terex Corporation ou de ses filiales.

Dezember 2019. Irrtum und Änderungen der Produktspezifikationen vorbehalten. Die in diesem Dokument enthaltenen Fotos und/oder Zeichnungen dienen rein anschaulichen Zwecken. Für den sachgemäßen Gebrauch der Maschinen ist das entsprechende Bedienerhandbuch heranzuziehen. Unsachgemäßer Umgang mit bzw. unsachgemäßem Einsatz unserer Maschinen kann zu schweren gesundheitlichen Schäden bis hin zum Tod führen. Für unsere Produkte wird ausschließlich die entsprechende, schriftlich niedergelegte Standardgarantie gewährt. Terex leistet keinerlei darüber hinausgehende Garantie, weder ausdrücklich noch stillschweigend. Die genannten Produkte und Dienstleistungen sind in den USA und anderen Ländern ggf. Marken, Dienstleistungsmarken oder Handelsnamen der Terex Corporation und/oder ihrer Tochtergesellschaften. Alle Rechte vorbehalten. Terex, das Terex Kronenlogo und Works For You sind Marken in Eigentum der Terex Corporation bzw. ihrer Tochtergesellschaften.

Dicembre 2019. Specifiche e prezzi dei prodotti sono soggetti a modifica senza preavviso o altro obbligo. Le fotografie e i disegni in questo documento hanno esclusivamente scopo illustrativo. Consulta il Manuale dell'operatore pertinente per trovare istruzioni per l'utilizzo corretto di questo macchinario. La mancata osservanza delle istruzioni contenute nel relativo Manuale dell'operatore durante l'uso del macchinario e altri comportamenti irresponsabili possono provocare gravi lesioni, anche mortali. L'unica garanzia applicabile ai nostri macchinari è la garanzia scritta standard applicabile al particolare prodotto e alla particolare vendita e Terex è esonerata dal fornire qualsiasi altra garanzia, esplicita o implicita. I prodotti e servizi elencati possono essere dei marchi di fabbrica, marchi di servizio o nomi commerciali di Terex Corporation, e/o delle rispettive società affiliate negli Stati Uniti d'America e in molte altre nazioni. Tutti i diritti riservati. Terex, il marchio Terex Crown e Works for You sono marchi di proprietà di Terex Corporation o delle sue società affiliate.

Diciembre 2019. Las especificaciones y los precios de los productos están sujetos a cambios sin necesidad de previo aviso ni ninguna otra obligación. Las fotografías y/o dibujos de este documento tienen un fin meramente ilustrativo. Consulte el correspondiente manual de instrucciones del operario para obtener más información sobre el uso correcto de esta maquinaria. No respetar el manual del operario al utilizar la maquinaria o actuar de forma irresponsable puede provocar lesiones graves e incluso mortales. La única garantía aplicable a nuestra maquinaria es la garantía escrita estándar de cada producto y venta. Terex no amplía dicha garantía de forma expresa ni implícita. Los productos y servicios mencionados pueden ser marcas comerciales, marcas de servicio o nombres de marca de Terex Corporation o de alguna de sus filiales en Estados Unidos y otros países. Todos los derechos reservados. Terex, el diseño de la corona Terex y Works For You son marcas registradas de Terex Corporation o de sus filiales.

Dezembro 2019. Especificações e preços dos produtos sujeitos a alteração sem aviso prévio ou obrigações. As fotografias e/ou desenhos neste documento são apenas para fins ilustrativos. Consulte o respectivo Manual do Operador para instruções sobre o uso correto deste equipamento. Deixar de acompanhar o respectivo Manual do Operador ao usar o nosso equipamento ou, por qualquer outra forma, deixar de agir de maneira responsável pode resultar em lesões corporais graves ou a morte. A única garantia aplicável ao nosso equipamento é a garantia padrão por escrito correspondente ao produto específico vendido. A Terex não dá outras garantias, expressas ou implícitas. Os produtos e serviços listados podem ser marcas comerciais, marcas de serviço ou nomes-fantasia da Terex Corporation e/ou suas subsidiárias nos EUA e em outros países. Todos os direitos reservados. Terex, o desenho da Coroa Terex e a expressão Works For You são marcas comerciais da Terex Corporation ou suas subsidiárias.

Декабрь 2019 г. года Технические характеристики и цены могут изменяться без предварительного уведомления и без каких-либо обязательств для производителя. Фотографии и (или) чертежи в настоящем документе служат только в качестве иллюстраций. Инструкции по надлежащей эксплуатации данного оборудования см. в соответствующем руководстве для оператора. Невыполнение указаний соответствующих руководств для оператора при эксплуатации оборудования или другие безответственные действия могут повлечь серьезные травмы или смерть. Единственной гарантией, действующей в отношении нашего оборудования, является стандартная форма письменной гарантии на данный тип оборудования и на условия его продажи. Terex не дает никаких других гарантий: ни ясно выраженных, ни подразумеваемых. Перечисленные продукты и услуги могут быть торговыми марками, знаками обслуживания или торговыми наименованиями Terex Corporation и / или ее дочерних компаний в США и других странах. Все права защищены. Terex, изображение короны Terex и Works for You являются торговыми марками, принадлежащими корпорации Terex или ее дочерним компаниям.



www.terex.com/cranes

Brochure Reference: RT-DS-M-E/F/G//S/P/R-RT 1080L-12/19



WORKS FOR YOU.™